

# Part No. 19160511RC PEUGEOT

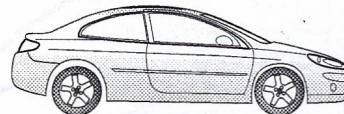

SUPPLIERS OF TOWBAR WIRING KITS FOR THE UK

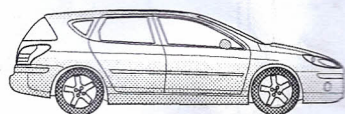
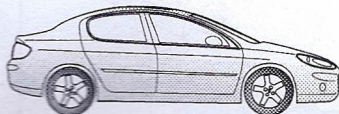

407 Saloon

05/04 →

407 Station Wagon

09/04 →

407 Coupé

10/05 →

## Electric wiring kit for towbars / 7-pin / 12N / 12 Volt / ISO 1724 Fitting instructions

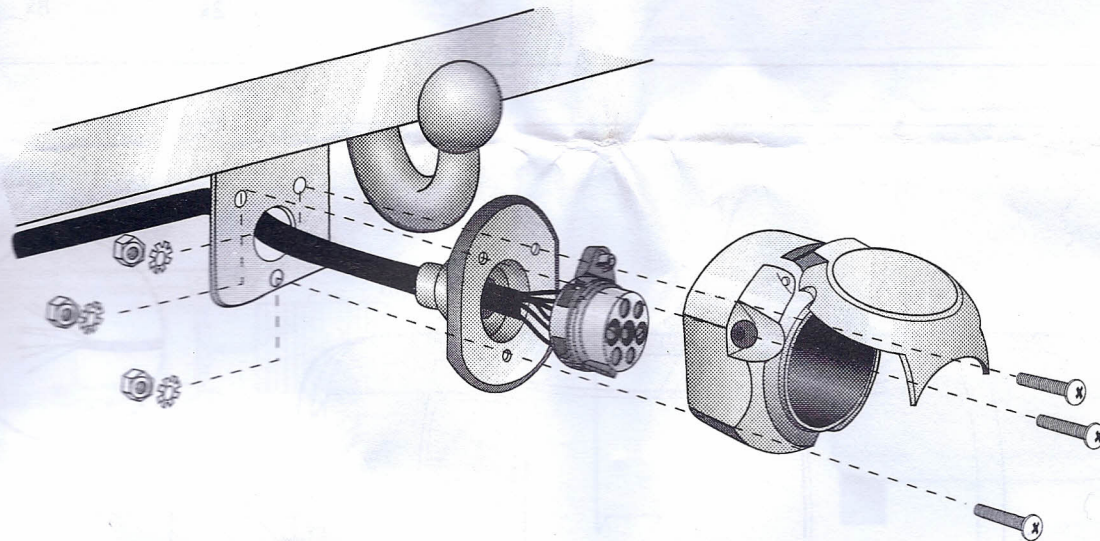

**IMPORTANT!**



Installation of the towing electrics kit must be undertaken by a specialist workshop or an appropriately qualified person. Before starting work, you must read the installation instructions through completely. After installing the towing electrics kit, the installation instructions should be kept with the vehicle service documentation.

All claims under the guarantee will lapse in case of improper use or modification of the towing electrics kit or any of its component parts. When driving without a trailer or load carrier, any adapter installed must be removed from the electrical socket. We reserve the right to alter the design, content or colour. We accept no liability for any errors in these instructions. All details and illustrations are non-binding.

In case of missing a rear fog lamp on the trailer, it should be retrofitted.

We accept no responsibility and give no guarantee for technical and electrical modifications made after the initial operation of the towing electrics kit by the vehicle manufacturer and which may lead, for example to malfunction of the trailer socket or its peripheries.

The trailer module is not diagnostics-capable. If the manufacturer's diagnostics processes or software-supported test mechanisms generate error reports directly or indirectly linked with trailer operation, the trailer module must be disconnected from the leads to the trailer socket and a new diagnostic process initiated.

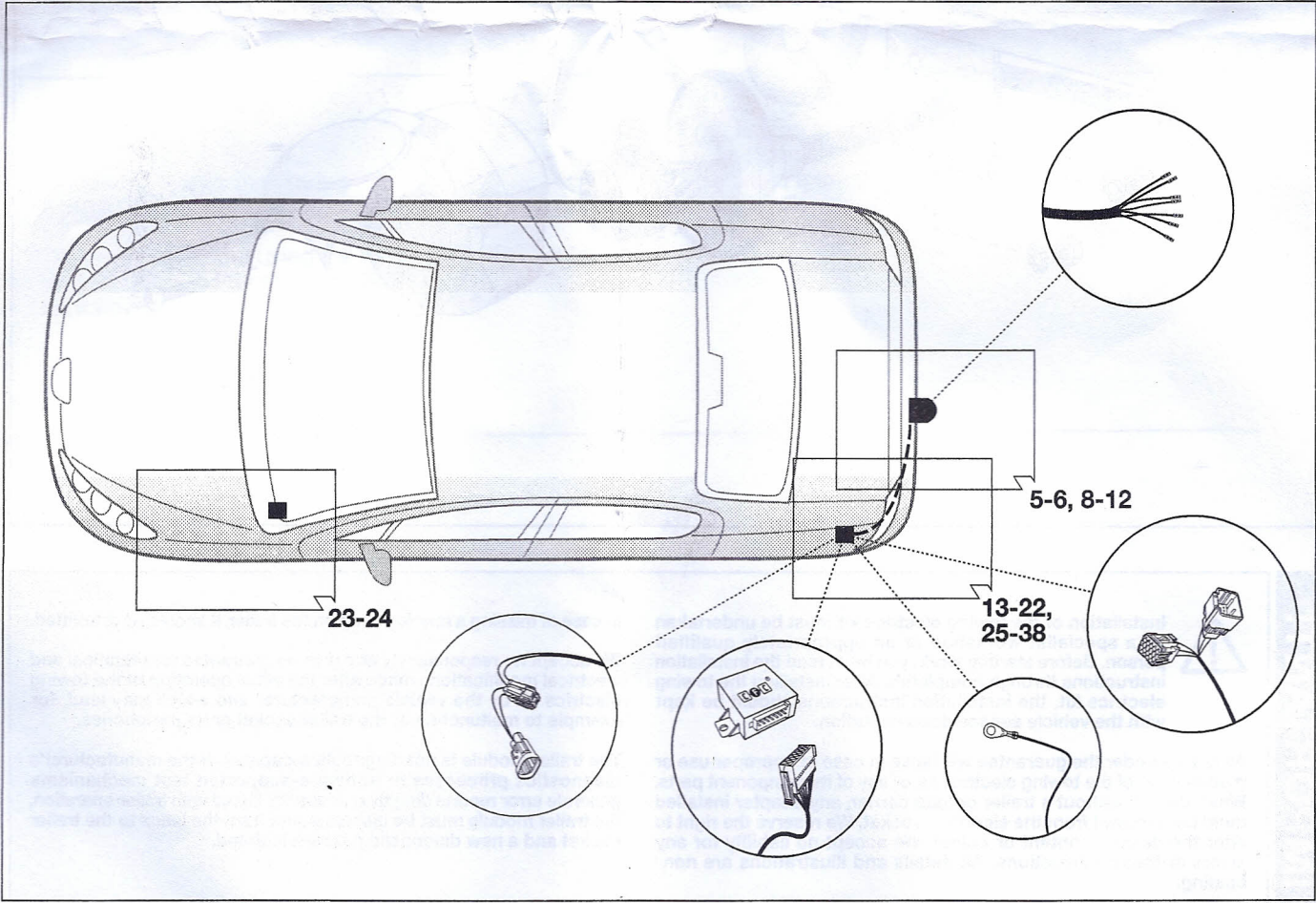
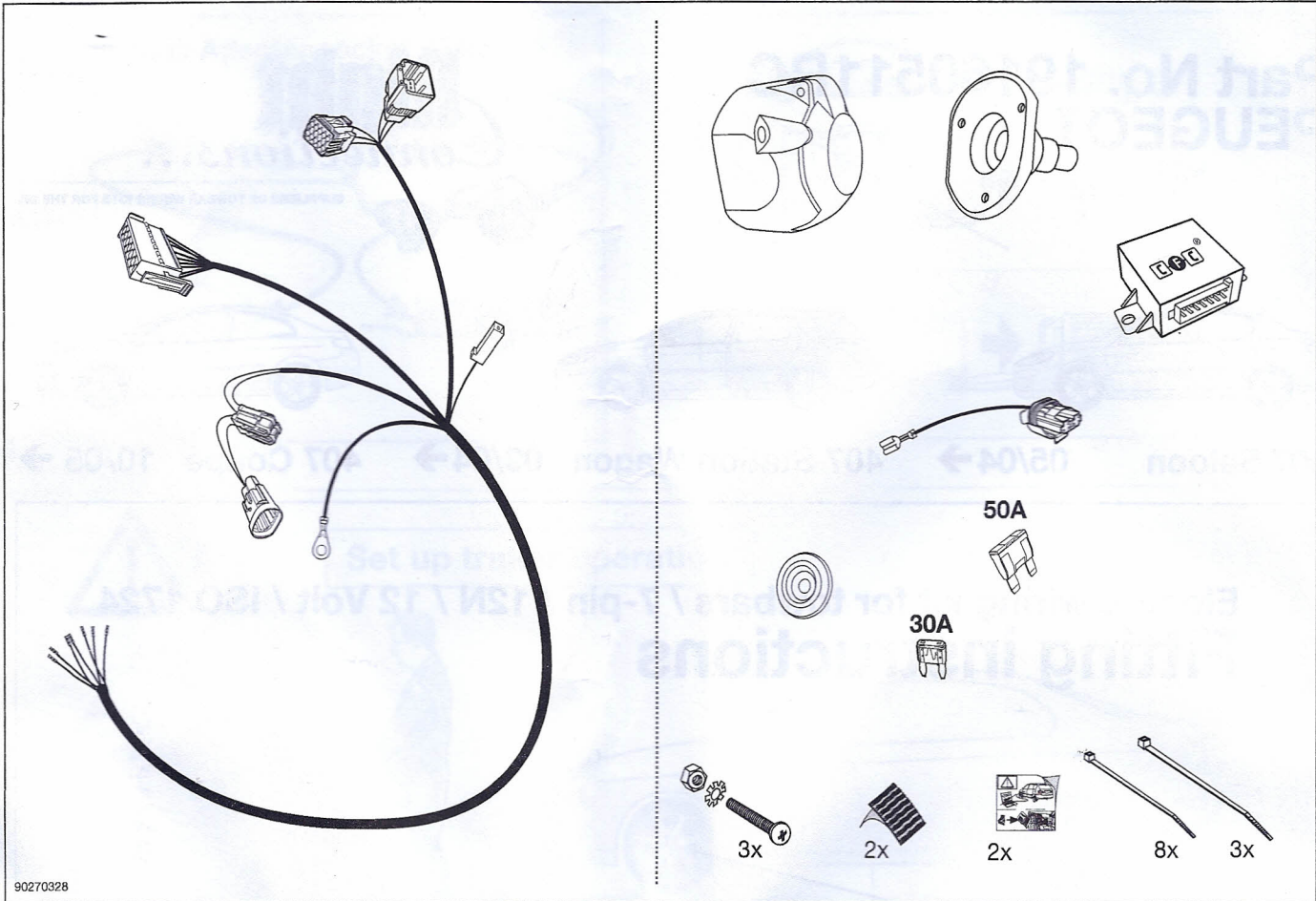

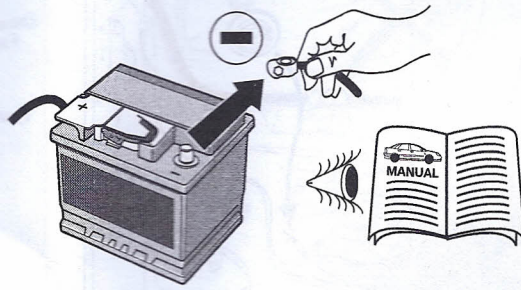

## IMPORTANT!

In order to avoid mal-functions and damage to the vehicle's electrical system the earth terminal **must** be disconnected from the vehicle's battery **before** starting work!

Both the CFC trailer module and the vehicle's control unit for the electrical system can be damaged during work on the CAN data bus connections if the battery is not disconnected!

Please pay attention to the manufacturer's instructions when disconnecting and reconnecting the vehicle's battery!

90010216

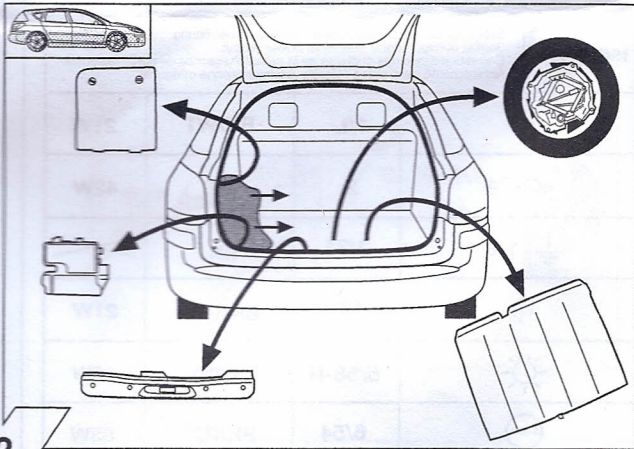

2

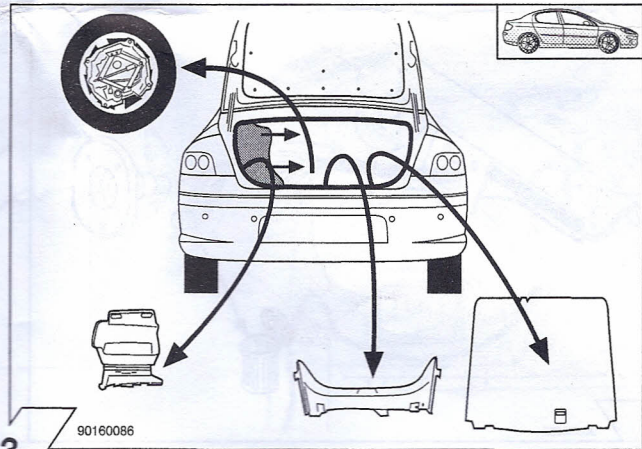

3

90160086

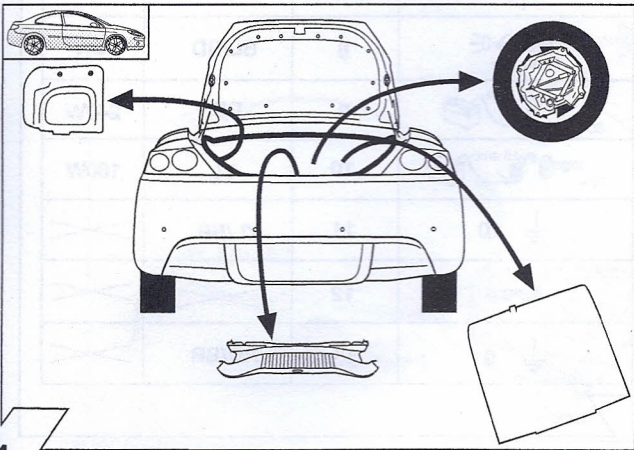

4

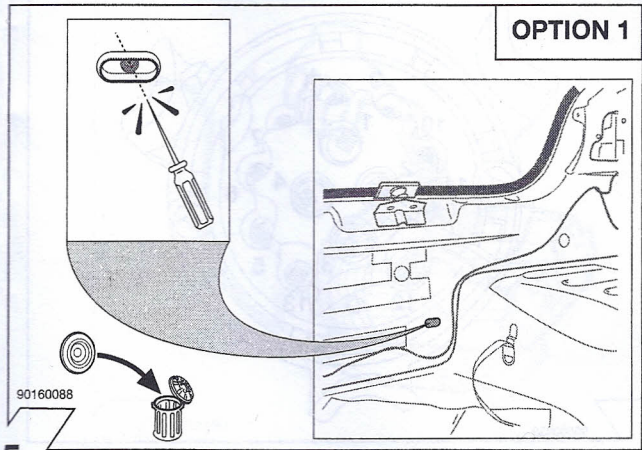

5

90160088

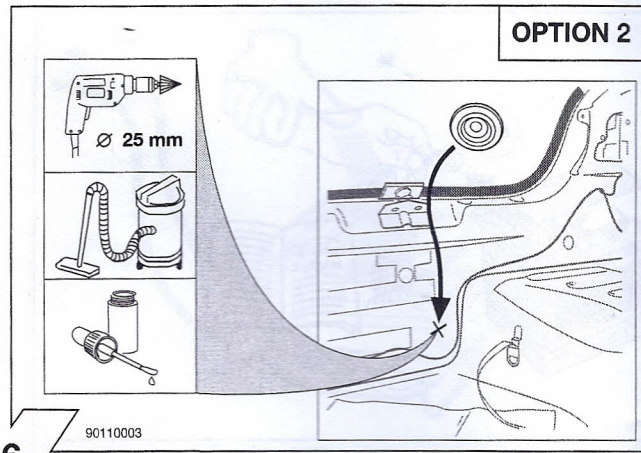

6

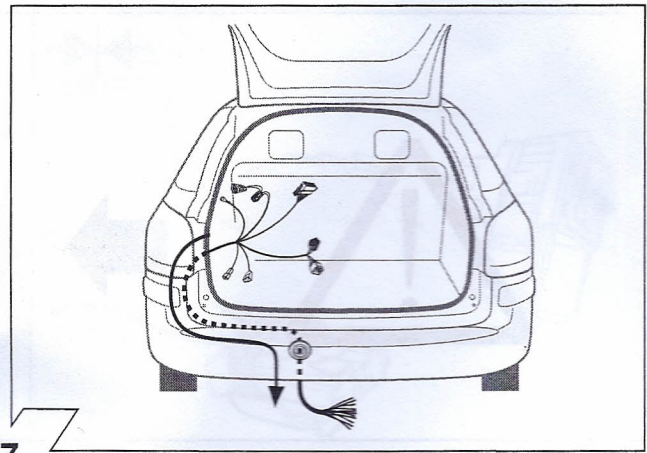

7

90500580

	GB	D	E	F	I	P	NL	DK	N	S	FIN	CZ	H	PL
BK	Black	Schwarz	Negro	Noir	Nero	Preto	Zwart	Sort	Svart	Svart	Musta	Černá	Fekete	Czarny
RD	Red	Rot	Rojo	Rouge	Rosso	Vermelho	Rood	Red	Red	Röd	Punainen	Červená	Piros	Czerwony
GN	Green	Grün	Verde	Vert	Verde	Verde	Groen	Grön	Grønt	Grön	Vihreä	Zelená	Zöld	Zielony
OR	Orange	Orange	Naranja	Orange	Arancione	Laranja	Oranje	Orange	Orange	Orange	Oranssi	Oranzová	Narancs	Pomarańczowy
VT	Violet	Violett	Violeta	Violet	Viola	Violeta	Violet	Violet	Fiolett	Violett	Violetti	Fialová	Ibolya	Fioletowy
PK	Pink	Pink	Pink	Rose	Rosa	Cor-de-Rosa	Paars	Pink	Pink	Rosa	Pinkki	Růžová	Rózsaszín	Różowy
BL	Blue	Blau	Azul	Bleu	Blu	Azul	Blauw	Blå	Blått	Blå	Sininen	Modrá	Kék	Niebieski
YL	Yellow	Gelb	Amarillo	Jaune	Giallo	Amarelo	Geel	Gul	Gult	Gul	Keltainen	Zlutá	Sárga	Żółty
WT	White	Weiss	Blanco	Blanc	Bianco	Branco	Wit	Hvid	Hvitt	Vit	Valkoinen	Bílá	Fehér	Biały
BR	Brown	Braun	Marrón	Brun	Marrone	Marrom	Bruin	Brun	Brunt	Brun	Ruskea	Hnědá	Barna	Brazowy
GY	Grey	Grau	Gris	Gris	Grigio	Cinzeno	Grijs	Grå	Grått	Grå	Harmaa	Sedá	Szürke	Szary

8

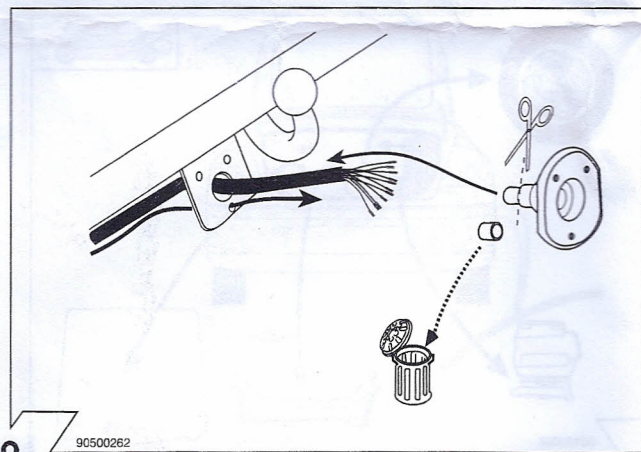

9

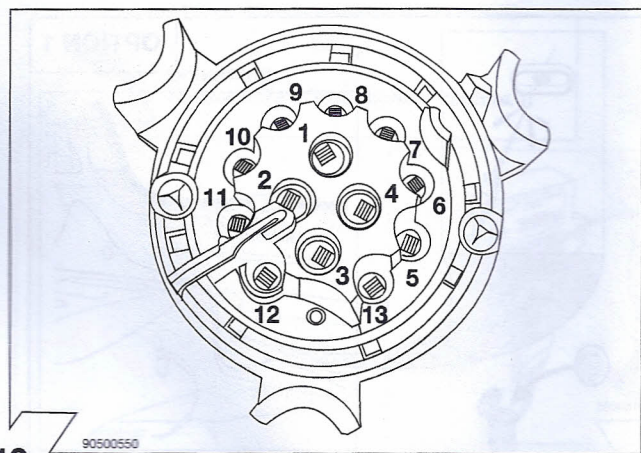

10

ISO 11446

Belegung der Steckdose / Maximale Ausgangsleistung  
 Socket configuration / Maximum power output  
 Correspondance des contacts de la prise / Puissance de sortie maximale  
 Abbinamento della presa / Uscita di alimentazione massima

↔	1/L	BK/WT	21W
⚡	2	WT	42W
⏚ 1-8	3/31	BR	⏏
→	4/R	BK/GN	21W
☀	5/58-R	GY/RD	52W
STOP	6/54	BK/RD	63W
☀	7/58-L	GY/BK	52W
Reverse	8	BL/RD	42W
30+ ⚡ 20 amp	9	RD	240W
15+ ⚡ 15 amp	10	YL	180W
⏚ 10	11	YL/BR	⏏
⏏	12	⏏	⏏
⏚ 9	13	RD/BR	⏏

90020157

11

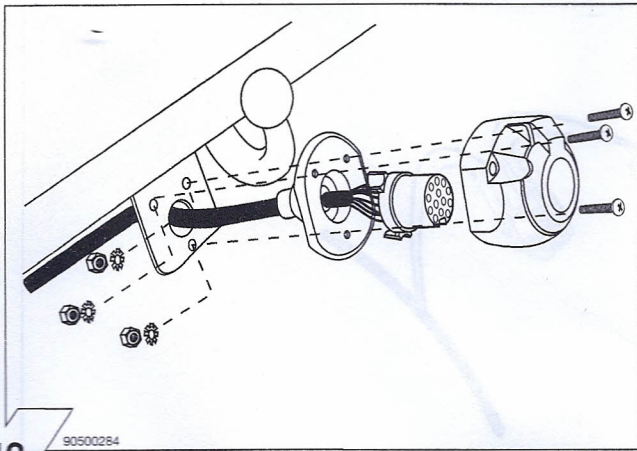

12

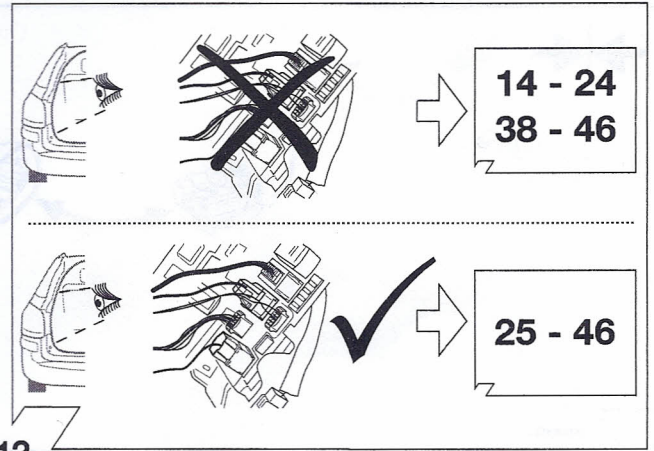

13

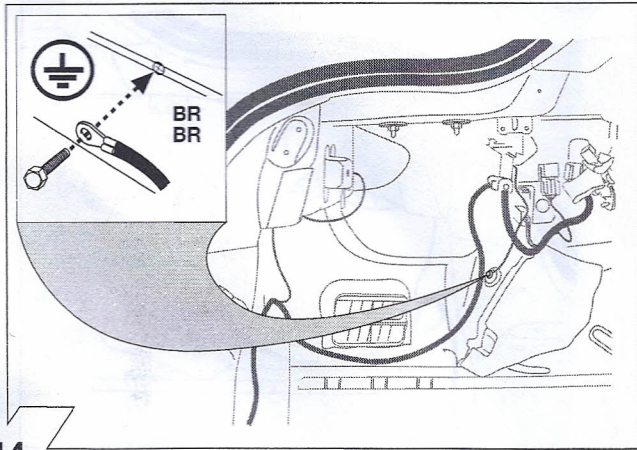

14

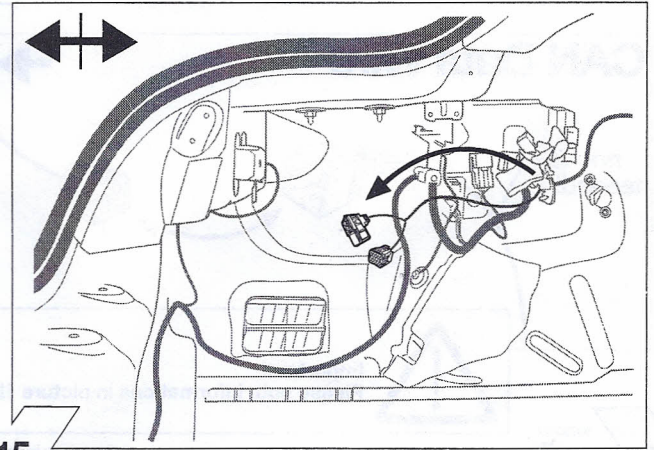

15

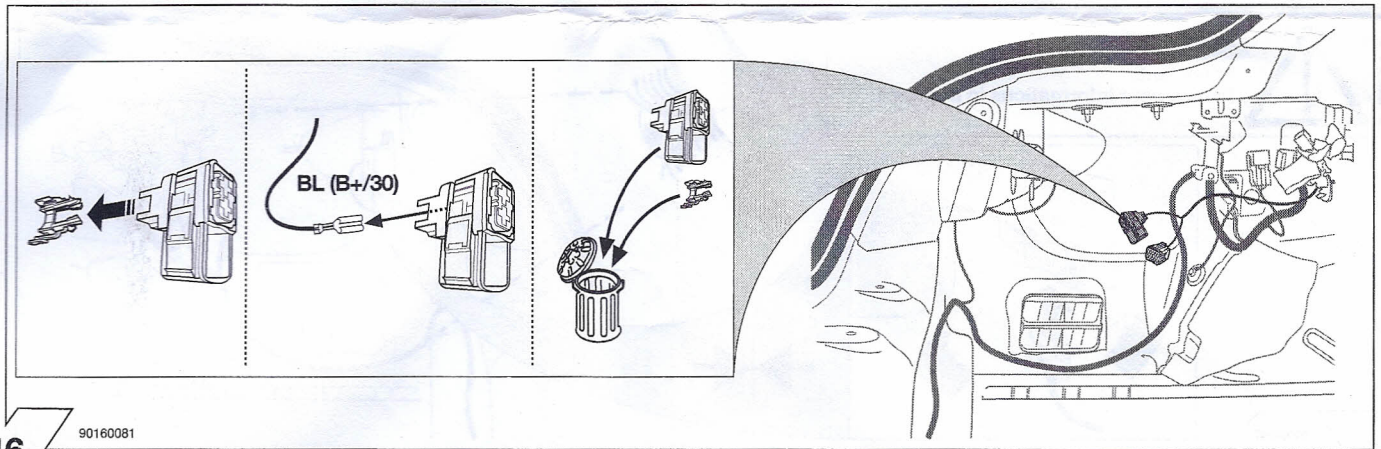

16

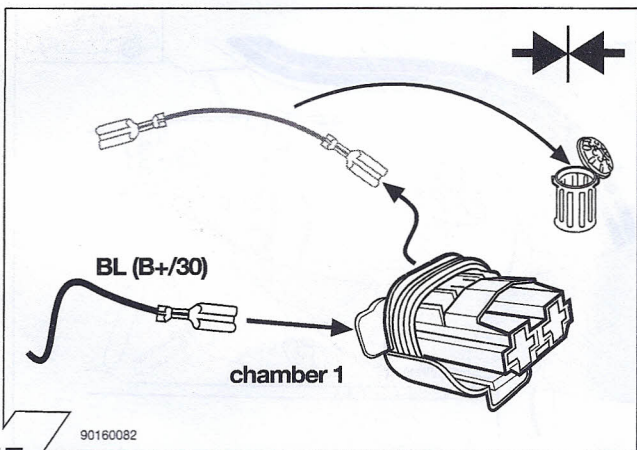

17

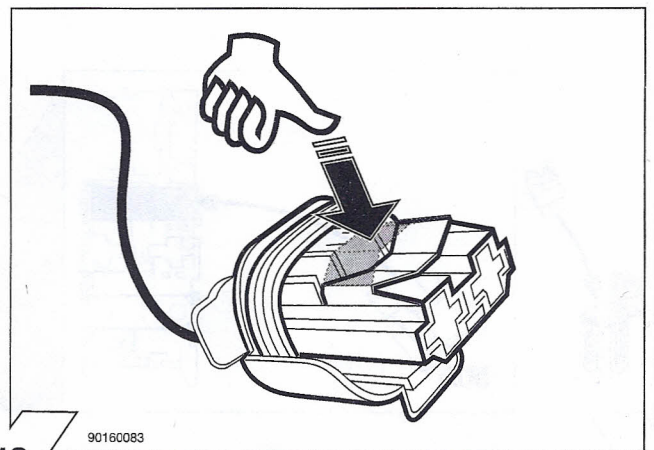

18

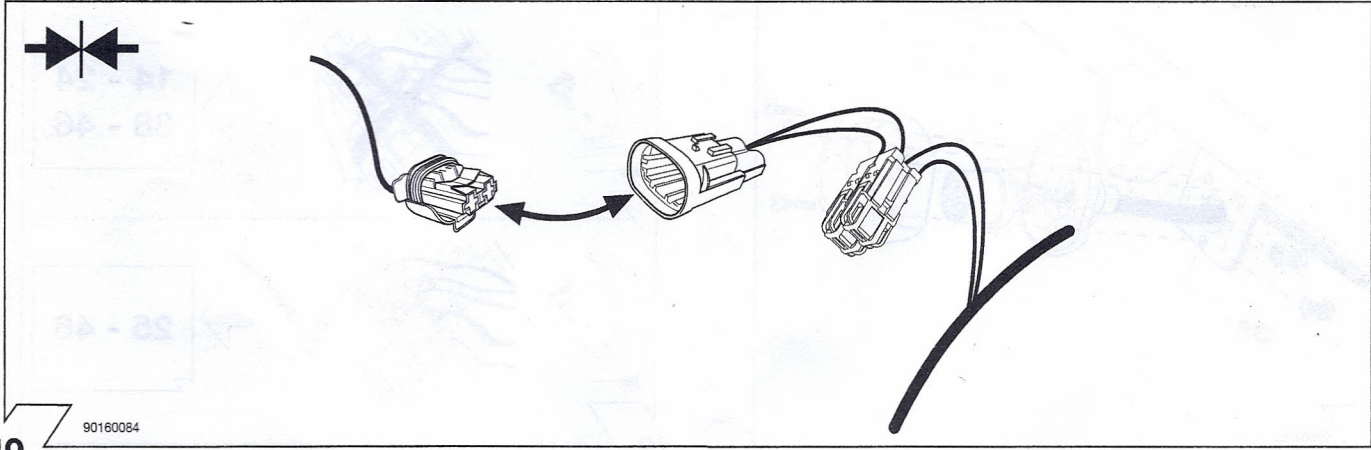

19

90160084

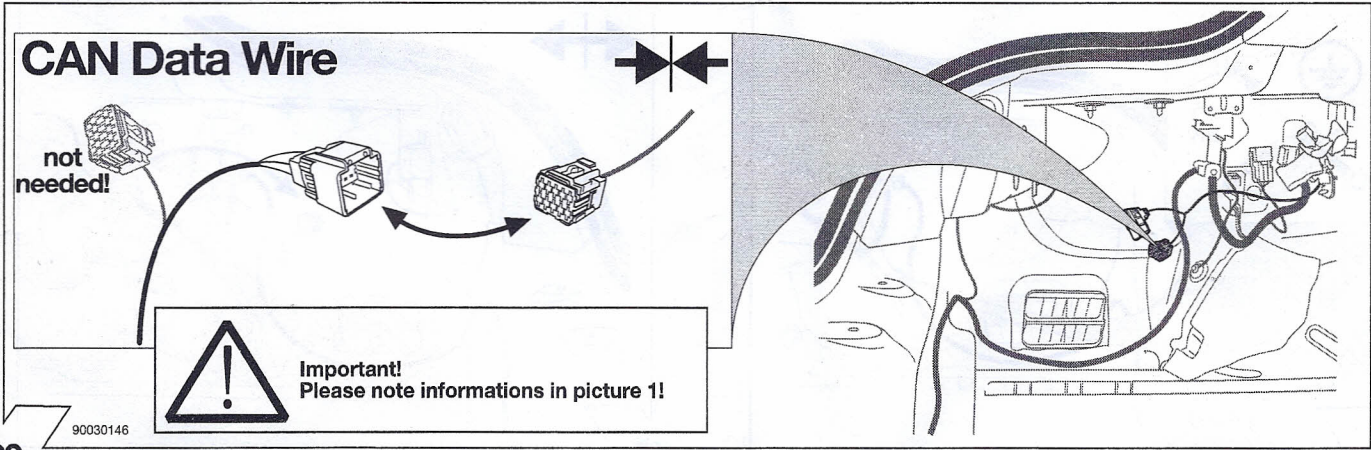

20

90030146

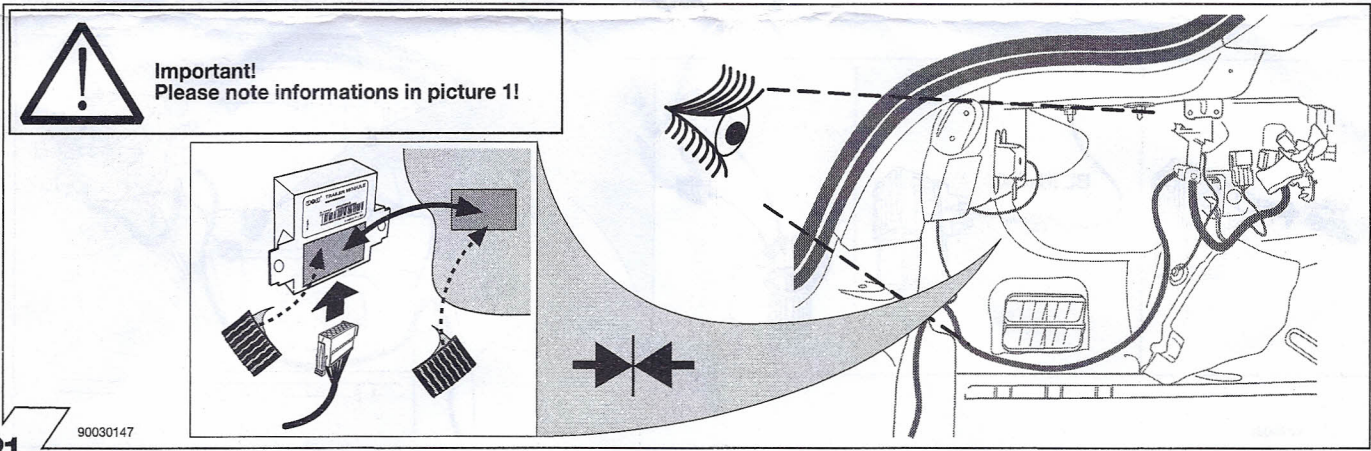

21

90030147

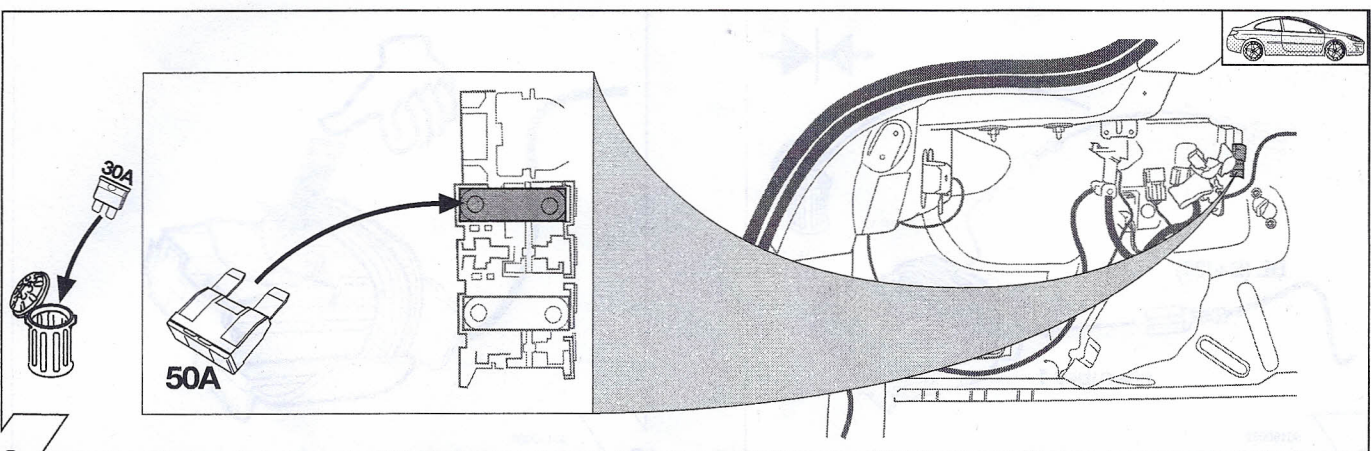

22

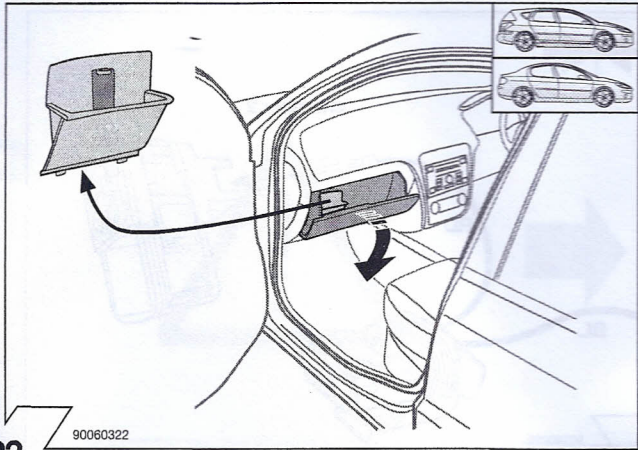

23

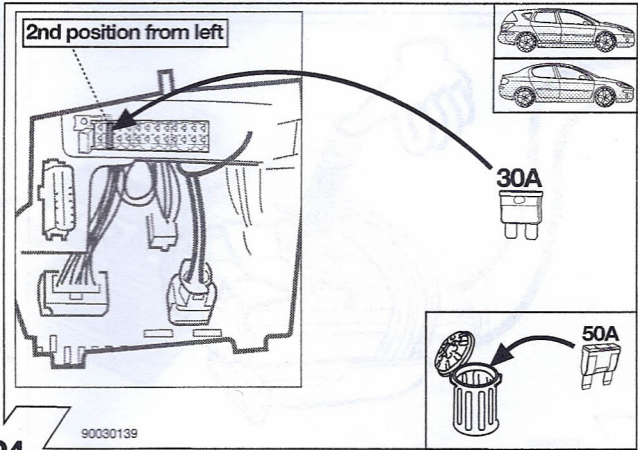

24

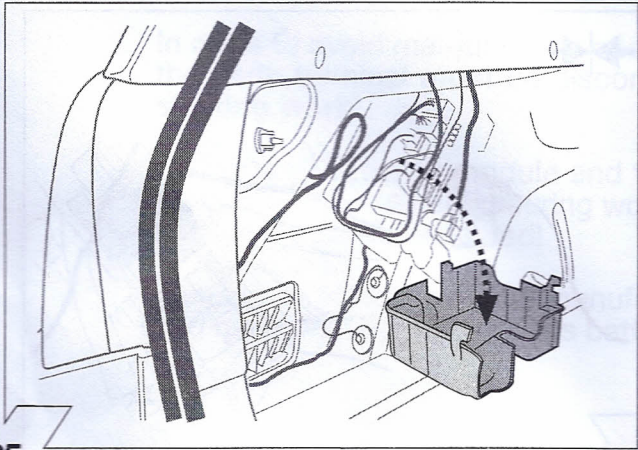

25

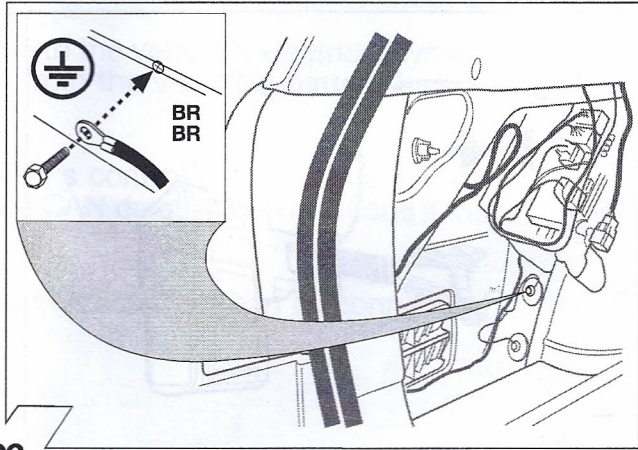

26

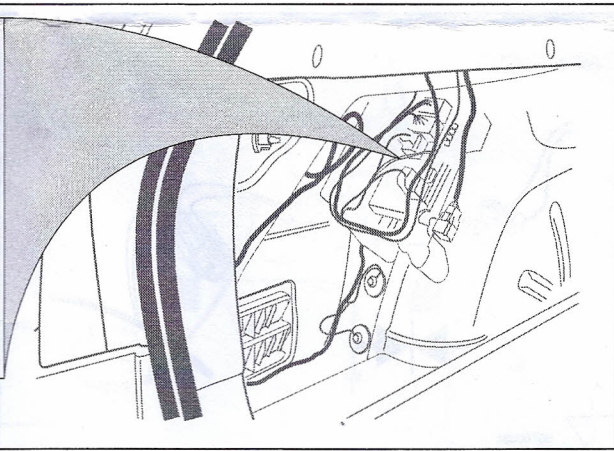
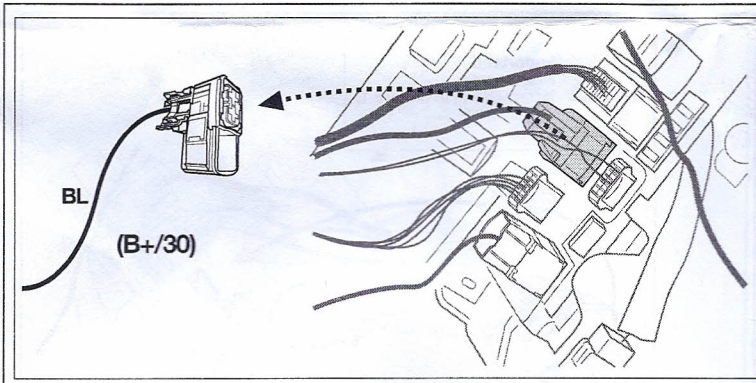

27

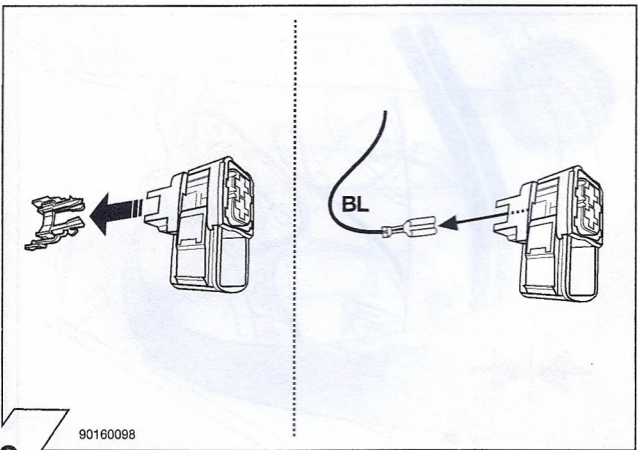

28

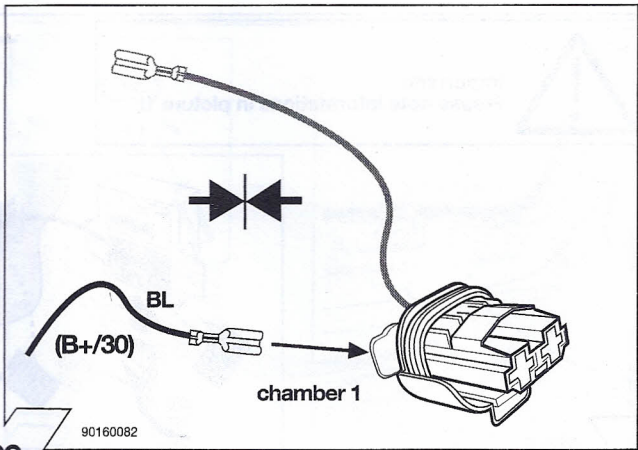

29

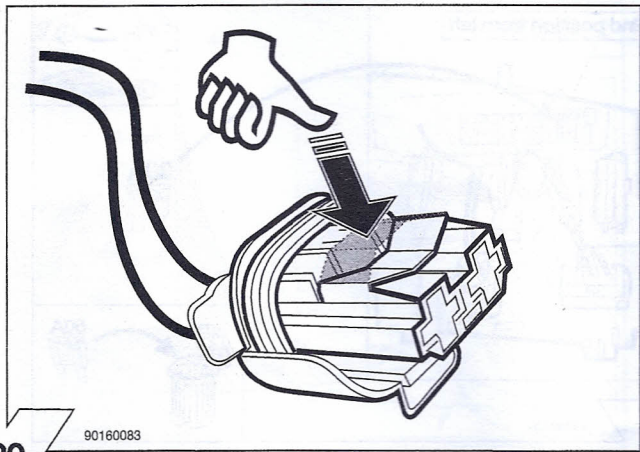

30

90160083

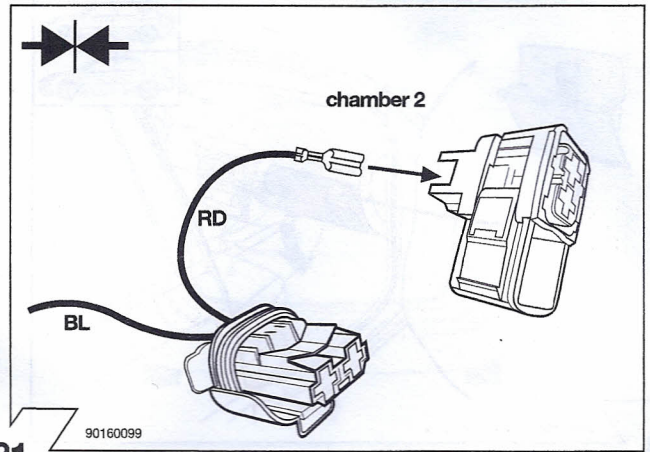

31

90160099

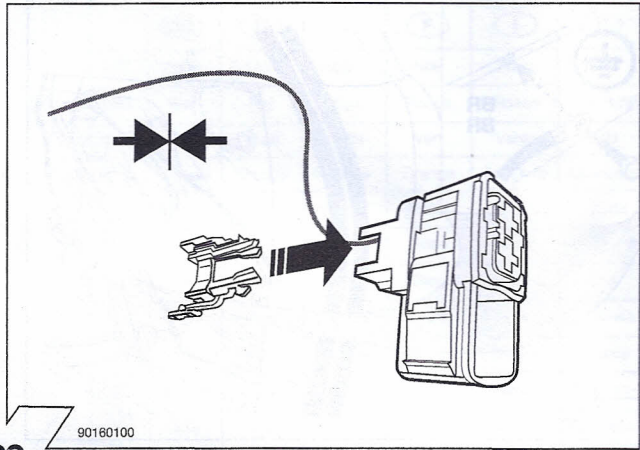

32

90160100

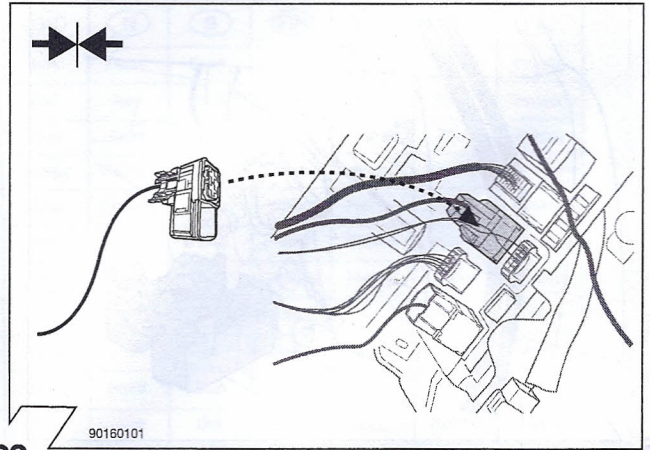

33

90160101

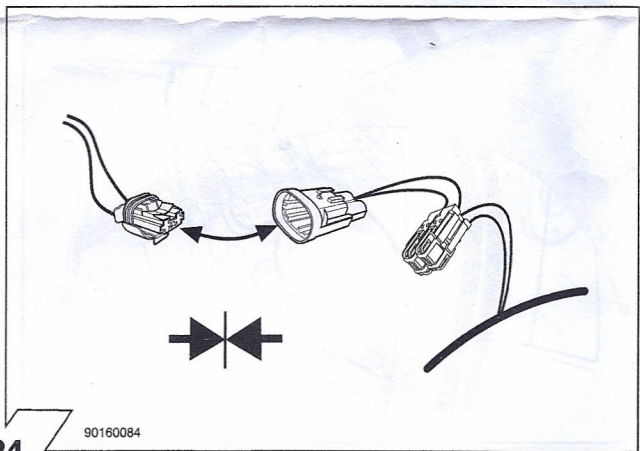

34

90160084

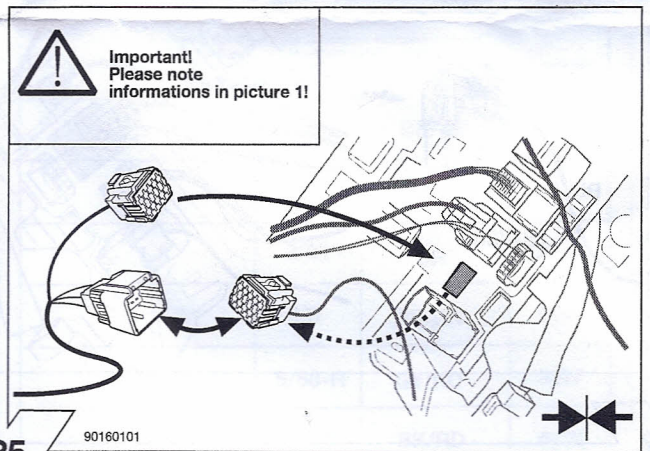

35

90160101

**Important!**  
Please note  
informations in picture 1!

**Important!**  
Please note  
informations in picture 1!

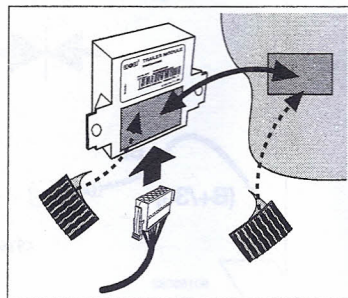

36

90030147

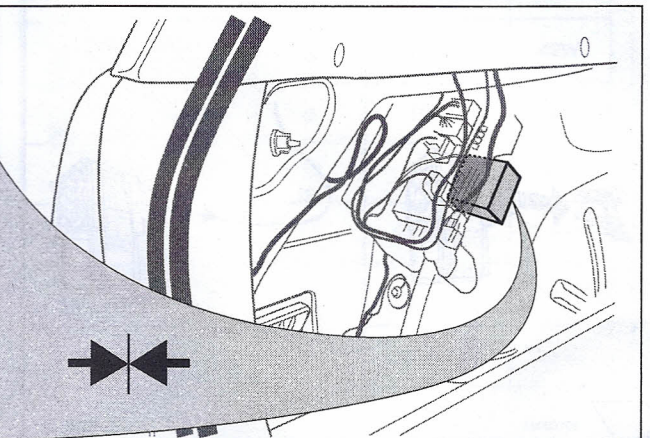



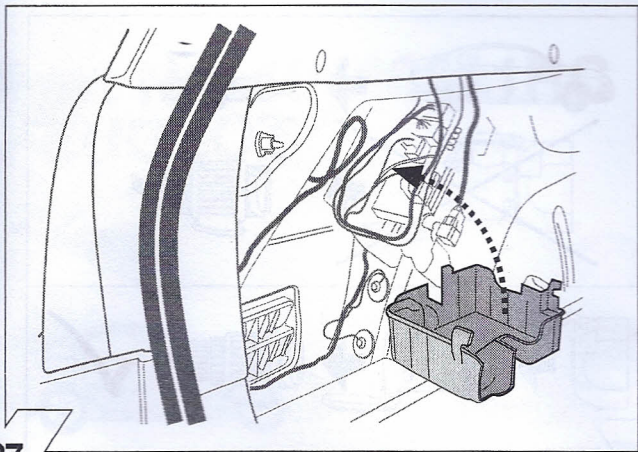

37

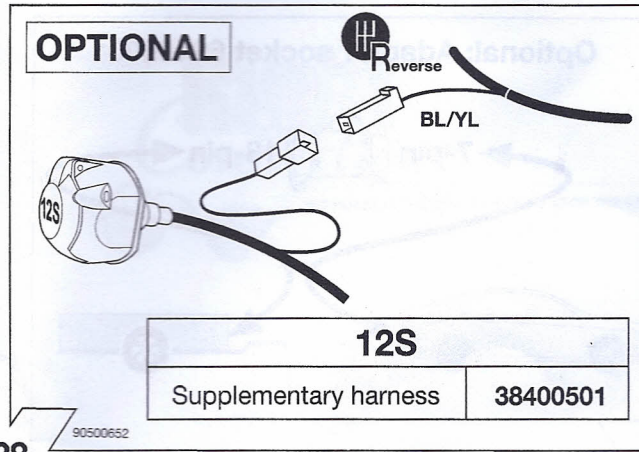

38

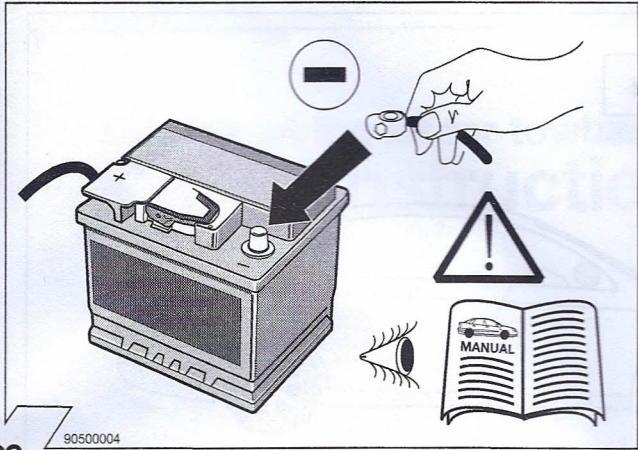

39

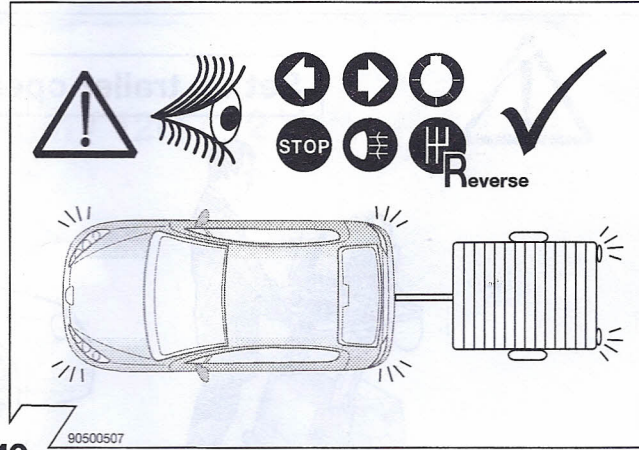

40

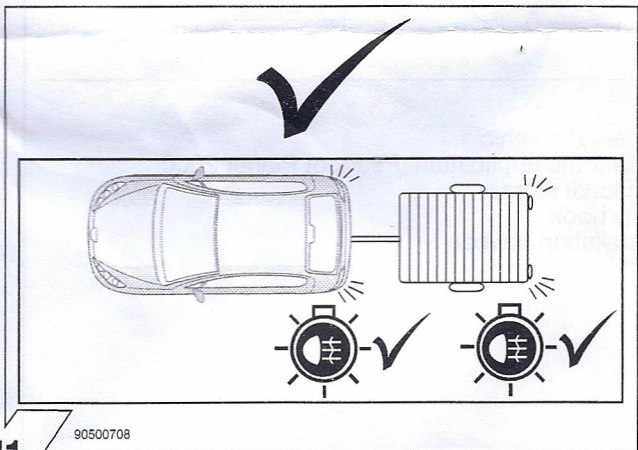

41

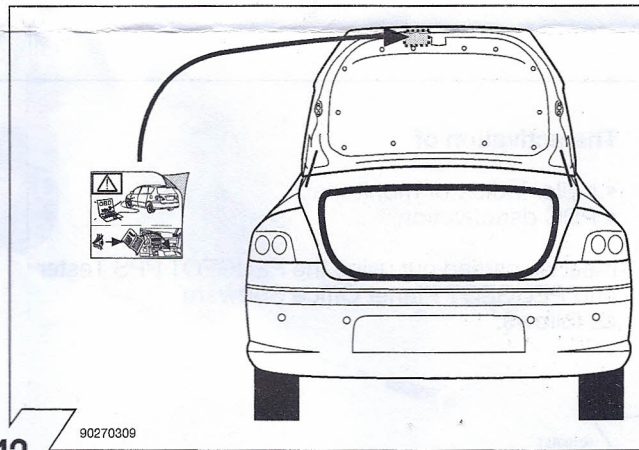

42

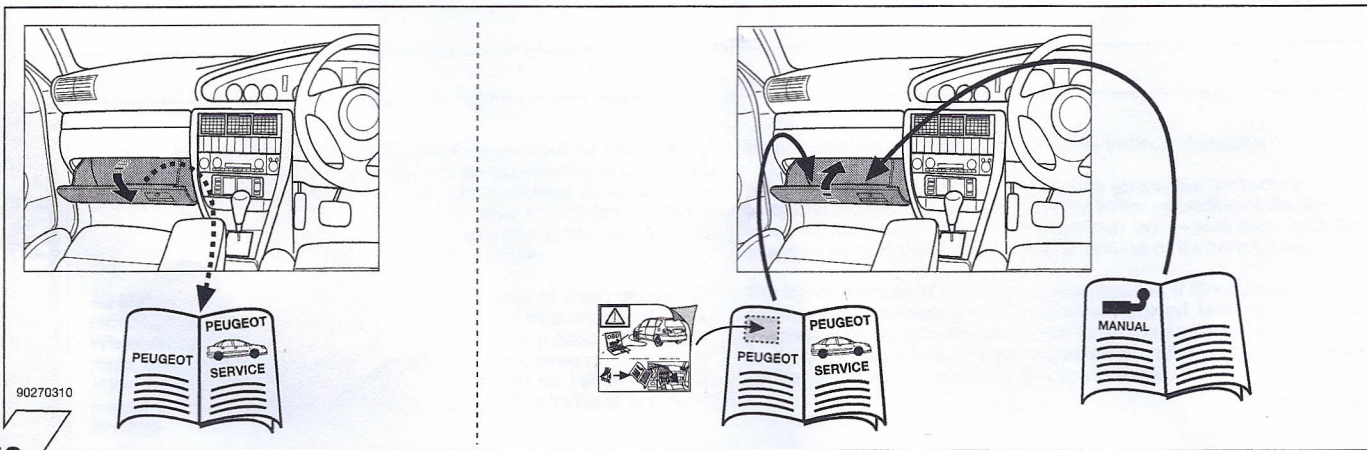

43

**Optional: Adapter socket 62400001**

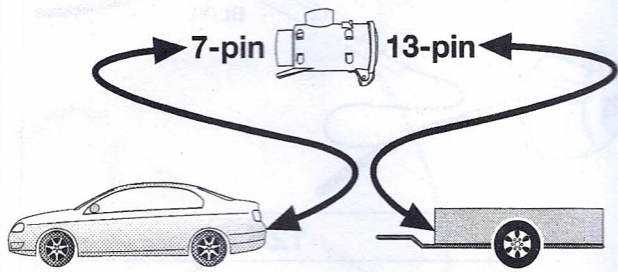

44

90500331

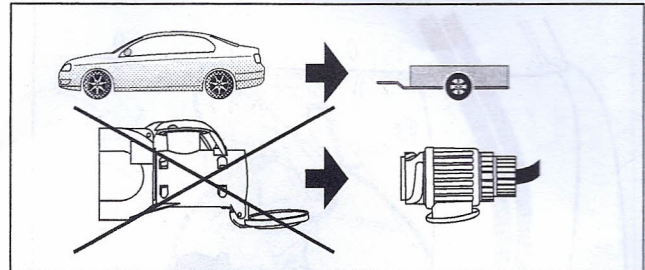

45

90500543

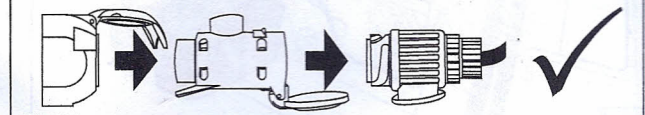

**Set up trailer operation**

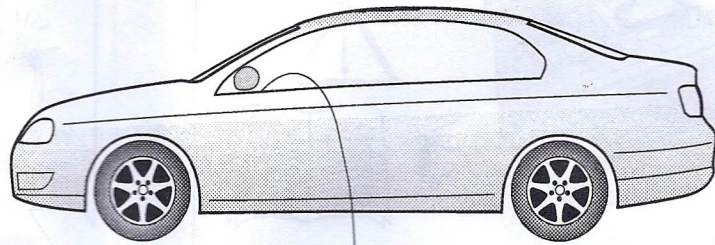
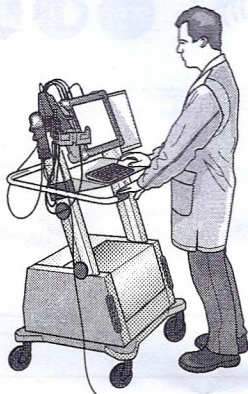

**The activation of**

- trailer indicator monitoring
- PDC deactivation

must be carried out using the PEUGEOT PPS Tester and PEUGEOT Planet Office Software as follows:

- Select the vehicle
- Select the application Peugeot Planet 2000
- Optional extras
- Tow hook
- Installation towbar

46

90160121